



**INSTITUTO DE CIENCIAS  
DE LA CONSTRUCCIÓN  
EDUARDO TORROJA**

C/ Serrano Galvache n. 4 28033 Madrid (Spain)  
Tel.: (34) 91 302 04 40 Fax: (34) 91 302 07 00  
direccion.ietcc@csic.es <https://dit.ietcc.csic.es>

## European Technical Assessment

## ETA 20/0046 of 16/03/2023

English translation prepared by IETcc. Original version in Spanish language

### General Part

**Technical Assessment Body issuing the ETA designated according to Art. 29 of Regulation (EU) 305/2011:**

Instituto de Ciencias de la Construcción Eduardo Torroja (IETcc)

**Trade name of the construction product:**

**Screw anchor THE**

**Product family to which the construction product belongs:**

Screw anchor of sizes 6, 8, 10, 12, 14, 16 and 18 for use in concrete.

**Manufacturer:**

**Index - Técnicas Expansivas S.L.**  
Segador 13  
26006 Logroño (La Rioja) Spain.  
website: [www.indexfix.com](http://www.indexfix.com)

**Manufacturing plant:**

Index plant 2

**This European Technical Assessment contains:**

23 pages including 3 annexes which form an integral part of this assessment.

**This European Technical Assessment is issued in accordance with regulation (EU) No 305/2011, on the basis of:**

European Technical Assessment EAD 330232-01-0601 "Mechanical Fasteners for use in concrete", ed. December 2019

**This ETA replaces:**

ETA 20/0046 issued on 18/03/2022



*English translation prepared by IETcc*

This European Technical Assessment is issued by the Technical Assessment Body in its official language. Translations of this European Technical Assessment in other languages shall fully correspond to the original issued document and should be identified as such.

This European Technical Assessment may be withdrawn by the issuing Technical Assessment Body, in particular pursuant to information by the Commission according to article 25 (3) of Regulation (EU) No 305/2011.

Código seguro de Verificación : GEN-3d93-e5f8-0299-b173-00eb-d087-276e-84a0 | Puede verificar la integridad de este documento en la siguiente dirección : <https://portafirmas.redsara.es/pf/valida>

---

CSV : GEN-3d93-e5f8-0299-b173-00eb-d087-276e-84a0

DIRECCIÓN DE VALIDACIÓN : <https://portafirmas.redsara.es/pf/valida>

FIRMANTE(1) : ANGEL CASTILLO TALAVERA | FECHA : 20/03/2023 18:55 | Sin acción específica



## SPECIFIC PART

### 1. Technical description of the product

The Index screw anchor THE is a fastener made of carbon steel of sizes 6, 8, 10, 12, 14, 16 and 18. The Index screw anchor TXE is a fastener made of stainless steel of sizes 6, 8, 10 and 12. The fastener is installed into a predrilled cylindrical hole. The special thread of the fastener cuts an internal thread into the concrete member while setting. The anchorage is characterised by mechanical interlock between fastener and concrete.

Product and installation descriptions are given in annex A.

### 2. Specification of the intended use in accordance with the applicable European Assessment Document.

The performances given in section 3 are only valid if the anchor is used in compliance with the specifications and conditions given in annex B.

The verifications and assessment methods on which this European Technical Assessment is based lead to the assumption of a working life of the anchor of at least 50 years. The indications given on the working life cannot be interpreted as a guarantee given by the producer, but are to be regarded only as a mean to choosing the right products in relation to the expected economically reasonable working life of the works.

### 3. Performance of the product and references to the methods used for its assessment

#### 3.1 Mechanical resistance and stability (BWR 1)

Essential characteristic	Performance
Essential characteristic under static or quasi static loading	See annexes C4 to C7
Displacements under tension and shear loads	See annexes C8 and C9
Essential characteristic and displacements for seismic performance categories C1 and C2	See annexes C10 to C12

#### 3.2 Safety in case of fire (BWR 2)

Essential characteristic	Performance
Reaction to fire	Anchorage satisfies requirements for class A1
Essential characteristics under fire exposure	See annexes C13 to C15

### 4. Assessment and Verification of Constancy of Performances (hereinafter AVCP) system applied, with reference to its legal base

The applicable European legal act for the system of Assessment and Verification of Constancy of Performances (see annex V to Regulation (EU) No 305/2011) is 96/582/EC.

The system to be applied is 1.



**5. Technical details necessary for the implementation of the AVCP system, as provided for in the applicable European Assessment Document.**

The technical details necessary for the implementation of the AVCP system are laid down in the quality plan deposited at Instituto de Ciencias de la Construcción Eduardo Torroja.



Instituto de Ciencias de la Construcción Eduardo Torroja  
CONSEJO SUPERIOR DE INVESTIGACIONES CIENTÍFICAS

C/ Serrano Galvache n.º 4. 28033 Madrid.  
Tel: (+34) 91 302 04 40 Fax. (+34) 91 302 07 00  
<https://dit.ietcc.csic.es>





On behalf of the Instituto de Ciencias de la Construcción Eduardo Torroja  
Madrid, 16<sup>th</sup> of March 2023

D. Ángel Castillo Talavera

Director IETcc - CSIC

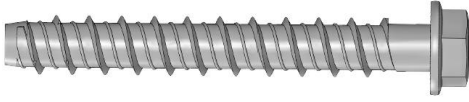
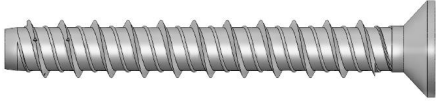
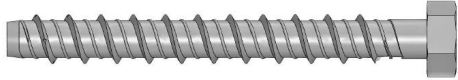
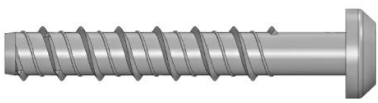
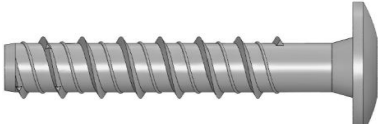
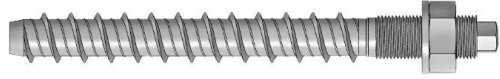
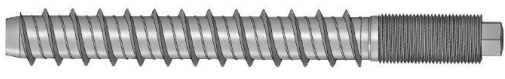

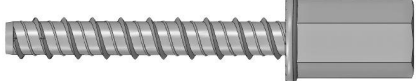
<b>Product types</b>		
<b>Picture</b>	<b>Material / coating</b>	<b>Sizes</b>
	Carbon steel: -H- Atlantis -F- Zinc plated -N- Zinc flake -K- Zinc nickel -G- Mechanical galvanized Stainless steel: -X- A4 stainless steel	-E, -K. Hexagonal head with flange. Sizes: 6, 8, 10, 12, 14, 16 and 18
		-A. Countersunk, Six lob recess Sizes: 6, 8 10 and 12
		-N. Hexagonal head. Sizes: 6, 8, 10, 12, 14, 16 and 18
		-P. Pan head. Six lob recess Sizes: 6 and 8
		-T. Truss head. Six lob recess. Size: 6
		-W. Stud head with DIN 934 class 6 nut and DIN 125 washer Sizes: 6, 8 and 10
		-S. Stud head Sizes: 6, 8 and 10
		-M. Male thread Size: 6, external thread M8; M10
		-F. Rod hanger Size 6: thread M8 / M10 Size 8: thread M10, M12 Size 10: thread M12 Size 12: thread M12
<b>THE, TXE screw anchor</b>		<b>Annex A1</b>
<b>Product description</b>		
Screw types		



**Installed condition**

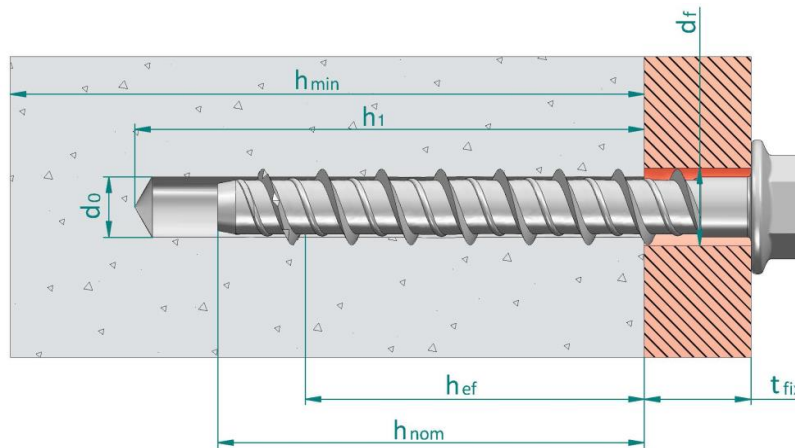

- $d_0$ : Nominal diameter of drill bit
- $d_f$ : Fixture clearance hole diameter
- $h_{ef}$ : Effective anchorage depth
- $h_1$ : Depth of drilled hole
- $h_{nom}$ : Overall fastener embedment depth in the concrete
- $h_{min}$ : Minimum thickness of concrete member
- $t_{fix}$ : Fixture thickness

Identification on head of fastener: company logo + size x length

The tip of the thread may be coloured

For heads where no space enough space is available, length mark can be replaced by the following letter codes.

Letter on head	Length [mm]
A	35 ÷ 50
B	51 ÷ 62
C	63 ÷ 75
D	76 ÷ 88
E	89 ÷ 101
F	102 ÷ 113
G	114 ÷ 126
H	127 ÷ 139
I	140 ÷ 153

**Table A1: Materials**

Item	Designation	Material for screw anchor THE	Material for screw anchor TXE
1	Fastener body	Carbon steel, galvanized $\geq 5 \mu\text{m}$ ISO 4042 Zn5 Carbon steel, zinc nickel $\geq 8 \mu\text{m}$ ISO 4042, ZnNi8/An/T2 Carbon steel, zinc flake $\geq 6 \mu\text{m}$ ISO 10683 Carbon steel, mechanical galvanizing $\geq 40 \mu\text{m}$ EN ISO 12683 Zn 40 M(Fe) Carbon steel, Atlantis coating	Shaft and head: stainless steel grade A4 ISO 3506-1 Tip: hardened carbon steel

**THE, TXE screw anchor**

**Product description**

Installed condition and materials

**Annex A2**



<b>Specifications of intended use</b>																
<b>Size</b>	<b>6</b>			<b>8</b>		<b>10</b>			<b>12</b>		<b>14</b>		<b>16</b>		<b>18</b>	
$h_{nom}$	35	40	55	50	65	55	75	85	75	105	75	115	80	120	90	140
<b>THE</b>																
Static or quasi static loads	✓	✓	✓	✓	✓	✓	✓	✓	✓	✓	✓	✓	✓	✓	✓	✓
Seismic category C1		✓	✓	✓	✓			✓		✓		✓				✓
Seismic category C2				✓	✓			✓		✓		✓				✓
Fire exposure up to 120 minutes	✓	✓	✓	✓	✓	✓	✓	✓	✓	✓	✓	✓	✓	✓	✓	✓
<b>TXE</b>																
Static or quasi static loads	✓	✓	✓	✓	✓	✓		✓	✓	✓						
Seismic category C1		✓	✓	✓	✓	✓		✓	✓	✓						
Seismic category C2																
Fire exposure up to 120 minutes	✓	✓	✓	✓	✓	✓		✓	✓	✓						
<b>Base materials:</b>																
<ul style="list-style-type: none"> <li>Reinforced or unreinforced normal weight concrete without fibres according to EN 206:2013 + A1:2016.</li> <li>Strength classes C20/25 to C50/60 according to EN 206:2013 + A1:2016.</li> <li>Cracked or uncracked concrete.</li> </ul>																
<b>Use conditions:</b>																
<ul style="list-style-type: none"> <li>THE: environmental conditions: anchorages subjected to dry internal conditions.</li> <li>TXE: environmental conditions: anchorages subjected to dry internal conditions, to external atmospheric exposure (including industrial and marine environment) or to permanent internal damp conditions if no particular aggressive conditions exist. Such particular aggressive conditions are e.g., permanent, alternating immersion in seawater or the splash zone of seawater, chloride atmosphere of indoor swimming pools or atmosphere with extreme chemical pollution (e.g., in desulphurization plants or road tunnels where de-icing materials are used). Atmospheres under Corrosion Resistance Class CRC III according to EN 1993-1-4:2006+A1:2015 annex A.</li> <li>Male and female version: the metric thread shall be equal or bigger than the net section of the concrete thread</li> </ul>																
<b>THE, TXE screw anchor</b>															<b>Annex B1</b>	
<b>Intended use</b>																
<b>Specifications</b>																



**Design:**

- Anchorages are designed under the responsibility of an engineer experienced in anchorages and concrete work.
- Verifiable calculation rules and drawings are prepared taking into account of the loads to be anchored. The position of the fastener is indicated on the design drawings (e.g., position of the fastener relative to reinforcement or to supports, etc.).
- Anchorages under static or quasi static actions are designed for design method A in accordance with EN 1992-4:2018.
- Anchorages under seismic actions are designed in accordance with EN 1992-4:2018. Anchorages shall be positioned outside of critical regions (e.g., plastic hinges) of the concrete structure. Fastening in stand-off installation or with grout layer are not allowed.
- Anchorages under fire exposure are designed in accordance with EN 1992-4:2018. It must be ensured that local spalling of the concrete cover does not occur.

**Installation:**

- Hole drilling by rotary plus hammer mode: all sizes and embedment depths.
- Fastener installation carried out by appropriately qualified personal and under the supervision of the person responsible for technical matters of the site.
- In case of aborted hole: new drilling at a minimum distance away of twice the depth of aborted hole or smaller distance if the aborted hole is filled with high strength mortar and if under shear or oblique tension load it is not the direction of the load application.
- After installation further turning of the anchor must not be possible.
- The head of the fastener must be supported on the fixture and is not damaged.

<b>THE, TXE screw anchor</b>	<b>Annex B2</b>
<b>Intended use</b>	
<b>Specifications</b>	





**Table C1: Installation parameters THE**

Installation parameters THE		Performances									
		6			8			10			
$h_{nom}$	Nominal embedment depth:	[mm]	35	40	55	50	65	55	75	85	
$h_{ef}$	Effective anchorage depth:	[mm]	26,0	30,0	43,0	37,5	50,5	41,5	58,5	67,0	
$d_0$	Nominal diameter of drill bit:	[mm]	6			8			10		
$d_f$	Clearance hole diameter $\leq$	[mm]	9			12			14		
$T_{inst,max}$	Installation torque $\leq$	[Nm]	10			20			30		
$h_1$	Depth of drilled hole $\geq$	[mm]	45	50	65	60	75	65	85	95	
$h_{min}$	Minimum thickness of concrete member:	[mm]	100	100	100	100	100	100	120	135	
$L_{min}$	Minimum total length of the fastener:	[mm]	35	40	55	50	65	55	75	85	
$t_{fix}$	Thickness of fixture <sup>1)</sup> :	[mm]	L-35	L-40	L-55	L-50	L-65	L-55	L-75	L-85	
SW	Socket size	Hexagonal type E:	10			13			15		
		Hexagonal type K:	10			13			17		
		Male:	13			13			--		
		Rod hanger:	M6: 10; M8: 11; M8/M10: 13; M10: 13; M12: 15								
TX	Six lob recess	Countersunk:	30			45			50		
		Pan:	40			45			--		
		Truss:	30			--			--		
$d_k$	Diameter of countersunk head:	[mm]	12,4			18			21		
$s_{min}$	Minimum allowable spacing:	[mm]	35			35			50		
$c_{min}$	Minimum allowable distance:	[mm]	35			35			40		
Setting tool			Bosch GDS 18E, 500 W. $T_{impact,max}$ 250 Nm, or equivalent			Makita TW0350, 400 W. $T_{impact,max}$ 350 Nm, or equivalent			Bosch GDS 24, 800 W. $T_{impact,max}$ 600 Nm, or equivalent		

<sup>1)</sup> L = total fastener length

Installation parameters THE		Performances										
		12		14		16		18				
$h_{nom}$	Nominal embedment depth:	[mm]	75	105	75	115	80	120	90	140		
$h_{ef}$	Effective anchorage depth:	[mm]	58,0	83,5	58,0	92,0	58,0	92,0	69,5	112,0		
$d_0$	Nominal diameter of drill bit:	[mm]	12		14		16		18			
$d_f$	Clearance hole diameter $\leq$	[mm]	16		18		20		22			
$T_{inst,max}$	Installation torque $\leq$	[Nm]	50		70		80		90			
$h_1$	Depth of drilled hole $\geq$	[mm]	90	120	90	130	100	140	110	160		
$h_{min}$	Minimum thickness of concrete member:	[mm]	120	170	120	185	115	185	140	225		
$L_{min}$	Minimum total length of the fastener:	[mm]	75	105	75	115	80	120	90	140		
$t_{fix}$	Thickness of fixture <sup>1)</sup> :	[mm]	L-75	L-105	L-75	L-115	L-80	L-120	L-90	L-140		
SW	Socket size:	Hexagonal type E:	18		21		24		24			
		Hexagonal type K:	19		21		24		26			
		Rod hanger:	15		--		--		--			
TX	Six lob recess countersunk	55		--		--		--				
$d_k$	Diameter of countersunk head:	[mm]	24		--		--		--			
$s_{min}$	Minimum allowable spacing:	[mm]	75		80		80		90			
$c_{min}$	Minimum allowable edge distance:	[mm]	45		50		50		55			
Setting tool			Bosch GDS 24, 800 W. $T_{impact,max}$ 600 Nm, or equivalent									

<sup>1)</sup> L = total fastener length

<b>THE screw anchor</b>	<b>Annex C1</b>
<b>Performances</b>	
Installation parameters	



**Table C2: Installation parameters TXE**

Installation parameters TXE			Performances								
			6			8		10		12	
$h_{nom}$	Nominal embedment depth:	[mm]	35	40	55	50	65	55	85	75	105
$h_{ef}$	Effective anchorage depth:	[mm]	26,0	30,0	43,0	37,5	50,5	41,5	67,0	58,0	83,5
$d_0$	Nominal diameter of drill bit:	[mm]	6			8		10		12	
$d_r$	Clearance hole diameter $\leq$	[mm]	9			12		14		16	
$T_{inst,max}$	Installation torque $\leq$	[Nm]	10			20		30		50	
$h_1$	Depth of drilled hole $\geq$	[mm]	45	50	65	60	75	65	95	90	120
$h_{min}$	Minimum thickness of concrete member:	[mm]	80	80	80	80	80	80	100	120	160
$L_{min}$	Minimum total length of the fastener:	[mm]	35	40	55	50	65	55	85	75	105
$t_{fix}$	Thickness of fixture <sup>1)</sup> :	[mm]	L-35	L-40	L-55	L-50	L-65	L-55	L-85	L-75	L-105
SW	Socket size, hexagonal type:	[mm]	10			13		15		18	
TX	Six lob recess, countersunk:	[-]	30			45		50		55	
$d_k$	Diameter of countersunk head:	[mm]	12,4			18		21		24	
$s_{min}$	Minimum allowable spacing:	[mm]	35			35		50		75	
$c_{min}$	Minimum allowable distance:	[mm]	35			35		40		45	
Setting tool			Bosch GDS 18E, 500 W. $T_{impact,max}$ 250 Nm, or equivalent			Bosch GDS 24, 800 W. $T_{impact,max}$ 600 Nm, or equivalent					

<sup>1)</sup> L = total fastener length

<b>TXE screw anchor</b>	<b>Annex C2</b>
<b>Performances</b>	
Installation parameters	



### Installation procedure

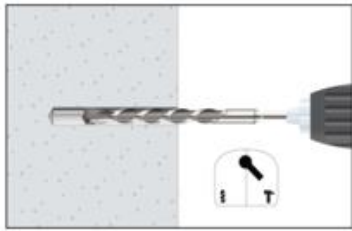

#### 1. DRILL

Drill a hole into the base material of the correct diameter and depth using a carbide drill bit in rotary plus hammer mode.



#### 2. BLOW AND CLEAN

Remove dust and debris from hole using a hand pump, compressed air or a vacuum to remove loose particles left from drilling.

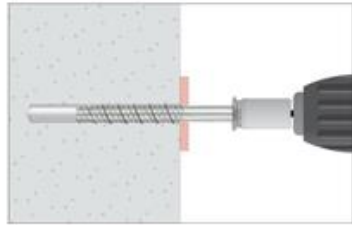

#### 3. INSTALL

Select a powered impact wrench or a torque wrench that does not exceed the maximum torque  $T_{\text{impact,max}}$  or  $T_{\text{inst,max}}$  respectively. Attach an appropriately sized hex socket or six lob bit to the wrench. Mount the screw anchor head in the socket / bit.

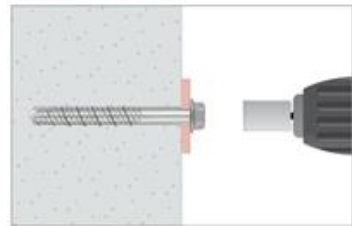

#### 4. APPLY TORQUE

Drive the anchor with an impact driver or a torque wrench through the fixture and into the hole until the anchor head comes in contact with the fixture. The anchor must be snug after installation. Do not spin the socket off the anchor to disengage.

<b>THE, TXE screw anchor</b>	<b>Annex C3</b>
<b>Performances</b>	
Installation procedure	



**Table C3: Essential characteristics under static or quasi-static tension loads of design method A according to EN1992-4, THE anchor**

Essential characteristics under static or quasi-static tension loads according to design method A, THE anchor			Performances								
			6			8			10		
$h_{nom}$	Nominal embedment depth:	[mm]	35	40	55	50	65	55	75	85	
<b>Tension loads: steel failure</b>											
$N_{Rk,s}$	Characteristic resistance:	[kN]	25,12			39,14			54,81		
$\gamma_{Ms}$	Partial safety factor <sup>1)</sup> :	[-]	1,4								
<b>Tension loads: pull-out failure in concrete</b>											
$N_{Rk,p}$	Characteristic resistance in C20/25 uncracked concrete:	[kN]	5	$\geq N_{Rk,c}^{0,2)}$							
$N_{Rk,p}$	Characteristic resistance in C20/25 cracked concrete:	[kN]	$\geq N_{Rk,c}^{0,2)}$								
$\psi_c$	Increasing factor for concrete	C30/37	[-]	1,16	1,12	1,22	1,21	1,22	1,22	1,17	1,22
		C40/50	[-]	1,28	1,22	1,41	1,39	1,41	1,41	1,30	1,41
		C50/60	[-]	1,39	1,29	1,58	1,54	1,58	1,58	1,42	1,58
<b>Tension loads: concrete cone and splitting failure</b>											
$h_{ef}$	Effective anchorage depth:	[mm]	26,0	30,0	43,0	37,5	50,5	41,5	58,5	67,0	
$K_{ucr,N}$	Factor for uncracked concrete:	[-]	11,0								
$K_{cr,N}$	Factor for cracked concrete:	[-]	7,7								
$S_{cr,N}$	Concrete Spacing:	[mm]	$3 \times h_{ef}$								
$C_{cr,N}$	cone failure Edge distance	[mm]	$1,5 \times h_{ef}$								
$S_{cr,sp}$	Spitting Spacing:	[mm]	90	90	170	130	200	140	190	210	
$C_{cr,sp}$	failure Edge distance	[mm]	45	45	85	65	100	70	95	105	
$\gamma_{inst}$	Robustness:	[-]	1,2	1,2	1,0	1,2	1,0	1,0	1,0	10	

<sup>1)</sup> In absence of other national regulations

<sup>2)</sup> Pull out failure is not decisive.  $N_{Rk,c}^{0,2}$  calculated according to EN 1992-4

Essential characteristics under static or quasi-static tension loads according to design method A, THE anchor			Performances								
			12		14		16		18		
$h_{nom}$	Nominal embedment depth:	[mm]	75	105	75	115	80	120	90	140	
<b>Tension loads: steel failure</b>											
$N_{Rk,s}$	Characteristic resistance:	[kN]	74,48		105,45		124,41		161,56		
$\gamma_{Ms}$	Partial safety factor <sup>1)</sup> :	[-]	1,4								
<b>Tension loads: pull-out failure in concrete</b>											
$N_{Rk,p}$	Characteristic resistance in C20/25 uncracked concrete:	[kN]	$\geq N_{Rk,c}^{0,2)}$								
$N_{Rk,p}$	Characteristic resistance in C20/25 cracked concrete:	[kN]	$\geq N_{Rk,c}^{0,2)}$								
$\psi_c$	Increasing factor for concrete	C30/37	[-]	1,16	1,22	1,21	1,20	1,12	1,16	1,22	1,17
		C40/50	[-]	1,29	1,41	1,39	1,37	1,21	1,28	1,40	1,32
		C50/60	[-]	1,40	1,58	1,55	1,51	1,29	1,39	1,57	1,42
<b>Tension loads: concrete cone and splitting failure</b>											
$h_{ef}$	Effective anchorage depth:	[mm]	58,0	83,5	58,0	92,0	58,0	92,0	69,5	112,0	
$K_{ucr,N}$	Factor for uncracked concrete:	[-]	11,0								
$K_{cr,N}$	Factor for cracked concrete:	[-]	7,7								
$S_{cr,N}$	Concrete Spacing:	[mm]	$3 \times h_{ef}$								
$C_{cr,N}$	cone failure Edge distance	[mm]	$1,5 \times h_{ef}$								
$S_{cr,sp}$	Spitting Spacing:	[mm]	190	220	190	230	180	280	230	350	
$C_{cr,sp}$	failure Edge distance	[mm]	95	110	95	115	90	140	115	175	
$\gamma_{inst}$	Robustness:	[-]	1,0								

<sup>1)</sup> In absence of other national regulations

<sup>2)</sup> Pull out failure is not decisive.  $N_{Rk,c}^{0,2}$  calculated according to EN 1992-4

**THE screw anchor**

**Performances**

Essential characteristics under static or quasi-static tension loads

**Annex C4**



**Table C4: Essential characteristics under static or quasi-static tension loads of design method A according to EN1992-4, TXE anchor**

Essential characteristics under static or quasi-static tension loads according to design method A, TXE anchor		Performances									
		6			8		10		12		
$h_{nom}$	Nominal embedment depth: [mm]	35	40	55	50	65	55	85	75	105	
<b>Tension loads: steel failure</b>											
$N_{Rk,s}$	Characteristic resistance: [kN]	17,58			29,30		48,13		69,67		
$\gamma_{Ms}$	Partial safety factor <sup>1)</sup> : [-]	1,5									
<b>Tension loads: pull-out failure in concrete</b>											
$N_{Rk,p}$	Characteristic resistance in C20/25 uncracked concrete: [kN]	5,5	$\geq N_{RkC}^{0,2)}$	12,0	10,0	$\geq N_{RkC}^{0,2)}$	$\geq N_{RkC}^{0,2)}$	$\geq N_{RkC}^{0,2)}$	$\geq N_{RkC}^{0,2)}$	$\geq N_{RkC}^{0,2)}$	
$N_{Rk,p}$	Characteristic resistance in C20/25 cracked concrete: [kN]	1,0	2,5	7,5	5,0	$\geq N_{RkC}^{0,2)}$	$\geq N_{RkC}^{0,2)}$	$\geq N_{RkC}^{0,2)}$	14,0	$\geq N_{RkC}^{0,2)}$	
$\Psi_c$	Increasing factor for concrete	C30/37 [-]	1,12	1,10	1,06	1,10	1,08	1,08	1,08	1,10	1,08
		C40/50 [-]	1,21	1,18	1,10	1,17	1,15	1,14	1,14	1,18	1,15
		C50/60 [-]	1,29	1,24	1,14	1,23	1,19	1,19	1,18	1,25	1,19
<b>Tension loads: concrete cone and splitting failure</b>											
$h_{ef}$	Effective anchorage depth: [mm]	26,0	30,0	43,0	37,5	50,5	41,5	67,0	58,0	83,5	
$k_{ucr,N}$	Factor for uncracked concrete: [-]	11,0									
$k_{cr,N}$	Factor for cracked concrete: [-]	7,7									
$S_{cr,N}$	Concrete cone failure Spacing: [mm]	$3 \times h_{ef}$									
$C_{cr,N}$	Edge distance [mm]	$1,5 \times h_{ef}$									
$S_{cr,sp}$	Spitting failure Spacing: [mm]	90	110	190	130	220	140	230	190	240	
$C_{cr,sp}$	Edge distance [mm]	45	55	95	65	110	70	115	95	120	
$\gamma_{inst}$	Robustness: [-]	1,2	1,2	1,2	1,2	1,2	1,2	1,2	1,2	1,0	

<sup>1)</sup> In absence of other national regulations

<sup>2)</sup> Pull out failure is not decisive.  $N_{RkC}^0$  calculated according to EN 1992-4

TXE screw anchor

Performances

Essential characteristics under static or quasi-static tension loads

Annex C5



**Table C5: Essential characteristics under static or quasi-static shear loads of design method A according to EN 1992-4, THE anchor**

Essential characteristics under static or quasi-static shear loads according to design method A, THE anchor		Performances								
		6			8			10		
$h_{nom}$	Nominal embedment depth: [mm]	35	40	55	50	65	55	75	85	
<b>Shear loads: steel failure without lever arm</b>										
$V_{Rk,s}$	Characteristic resistance: [kN]	12,53			19,57			27,40		
$k_7$	Ductility factor <sup>2)</sup> : [-]	0,78	0,80	0,78	0,80			0,80		
$\gamma_{Ms}$	Partial safety factor <sup>1)</sup> : [-]	1,5								
<b>Shear loads: steel failure with lever arm</b>										
$M^0_{Rk,s}$	Characteristic bending moment: [Nm]	21,6			44,6			78,3		
$\gamma_{Ms}$	Partial safety factor <sup>1)</sup> : [-]	1,5								
<b>Shear loads: concrete pryout failure</b>										
$k_8$	Pryout factor: [mm]	2,05	1,44	1,15	1,80	1,27	1,95	1,32	2,00	
$\gamma_{inst}$	Installation safety factor: [-]	1,0								
<b>Shear loads: concrete edge failure</b>										
$l_f$	Effective length of fastener under shear loads: [mm]	26,0	30,0	43,0	37,5	50,5	41,5	58,5	67,0	
$d_{nom}$	Outside fastener diameter: [mm]	6			8			10		
$\gamma_{inst}$	Installation safety factor: [-]	1,0								

- 1) In absence of other national regulations  
2) The diameter of the clearance hole does not meet the values given in EN 1992-4 Table 6.1. However, the group resistance under shear loading has been verified in the assessment through testing and accounted for in the factor  $k_7$

Essential characteristics under static or quasi-static shear loads according to design method A, THE anchor		Performances							
		12		14		16		18	
$h_{nom}$	Nominal embedment depth: [mm]	75	105	75	115	80	120	90	140
<b>Shear loads: steel failure without lever arm</b>									
$V_{Rk,s}$	Characteristic resistance: [kN]	37,24		52,72		57,97		80,78	
$k_7$	Ductility factor <sup>2)</sup> : [-]	1,00							
$\gamma_{Ms}$	Partial safety factor <sup>1)</sup> : [-]	1,5							
<b>Shear loads: steel failure with lever arm</b>									
$M^0_{Rk,s}$	Characteristic bending moment: [Nm]	126,5		218,3		279,75		421,2	
$\gamma_{Ms}$	Partial safety factor <sup>1)</sup> : [-]	1,5							
<b>Shear loads: concrete pry-out failure</b>									
$k_8$	Pry-out factor: [mm]	2,33	2,00	2,55	2,00	2,14	2,00	2,66	2,00
$\gamma_{inst}$	Installation safety factor: [-]	1,0							
<b>Shear loads: concrete edge failure</b>									
$l_f$	Effective length of fastener under shear loads: [mm]	58,0	83,5	58,0	92,0	58,0	92,0	69,5	112,0
$d_{nom}$	Outside fastener diameter: [mm]	12		14		16		18	
$\gamma_{inst}$	Installation safety factor: [-]	1,0							

- 1) In absence of other national regulations  
2) The diameter of the clearance hole does not meet the values given in EN 1992-4 Table 6.1. However, the group resistance under shear loading has been verified in the assessment through testing and accounted for in the factor  $k_7$

**THE screw anchor**

**Performances**

Essential characteristics under static or quasi-static shear loads

**Annex C6**



**Table C6: Essential characteristics under static or quasi-static shear loads of design method A according to EN 1992-4, TXE anchor**

Essential characteristics under static or quasi-static shear loads according to design method A, TXE anchor		Performances									
		6			8		10		12		
$h_{nom}$	Nominal embedment depth: [mm]	35	40	55	50	65	55	85	75	105	
<b>Shear loads: steel failure without lever arm</b>											
$V_{Rk,s}$	Characteristic resistance: [kN]	8,79			14,65		24,06		34,84		
$k_7$	Ductility factor <sup>2)</sup> : [-]	1,00									
$\gamma_{Ms}$	Partial safety factor <sup>1)</sup> : [-]	1,25									
<b>Shear loads: steel failure with lever arm</b>											
$M^0_{Rk,s}$	Characteristic bending moment: [Nm]	14,52			31,17		65,68		146,01		
$\gamma_{Ms}$	Partial safety factor <sup>1)</sup> : [-]	1,25									
<b>Shear loads: concrete pryout failure</b>											
$k_8$	Pryout factor: [mm]	1,87	1,66	1,05	1,71	1,39	1,83	2,00	2,19	2,00	
$\gamma_{inst}$	Installation safety factor: [-]	1,0									
<b>Shear loads: concrete edge failure</b>											
$l_f$	Effective length of fastener under shear loads: [mm]	26,0	30,0	43,0	37,5	50,5	41,5	67,0	58,0	83,5	
$d_{nom}$	Outside fastener diameter: [mm]	6			8		10		12		
$\gamma_{inst}$	Installation safety factor: [-]	1,0									

<sup>1)</sup> In absence of other national regulations

<sup>2)</sup> The diameter of the clearance hole does not meet the values given in EN 1992-4 Table 6.1. However, the group resistance under shear loading has been verified in the assessment through testing and accounted for in the factor  $k_7$

TXE screw anchor

Performances

Essential characteristics under static or quasi-static shear loads

Annex C7



**Table C7: Displacements under service loads THE anchor**

Displacements under service loads THE anchor		Performances								
		6			8			10		
$h_{nom}$	Nominal embedment depth: [mm]	35	40	55	50	65	55	75	85	
<b>Displacements under tension loads in uncracked concrete</b>										
N	Service tension load: [kN]	1,98	3,85	6,61	4,48	8,41	6,26	10,48	12,85	
$\delta_{N0}$	Short term displacement: [mm]	0,03	0,05	0,05	0,04	0,05	0,06	0,09	0,10	
$\delta_{N\infty}$	Long term displacement: [mm]	0,25	0,30	0,30	0,26	0,35	0,30	0,42	0,65	
<b>Displacements under tension loads in cracked concrete</b>										
N	Service tension load: [kN]	1,81	2,69	4,62	3,14	5,88	4,38	7,34	8,99	
$\delta_{N0}$	Short term displacement: [mm]	0,08	0,09	0,10	0,09	0,20	0,11	0,35	0,44	
$\delta_{N\infty}$	Long term displacement: [mm]	0,99	0,99	1,60	1,08	1,92	1,13	2,00	1,91	
<b>Displacements under shear loads in uncracked concrete</b>										
V	Service shear load: [kN]	5,97	5,54	5,97	9,32	9,32	12,21	13,05	13,05	
$\delta_{V0}$	Short term displacement: [mm]	1,50	1,61	1,70	1,03	1,03	1,11	1,21	1,24	
$\delta_{V\infty}$	Long term displacement: [mm]	2,25	2,41	2,55	1,54	1,54	1,66	1,81	1,86	
<b>Displacements under shear loads in cracked concrete</b>										
V	Service shear load: [kN]	4,46	3,88	5,32	6,78	7,47	8,55	9,68	13,05	
$\delta_{V0}$	Short term displacement: [mm]	0,95	0,96	1,45	0,66	0,70	0,74	1,03	1,09	
$\delta_{V\infty}$	Long term displacement: [mm]	1,42	1,44	2,17	0,99	1,05	1,11	1,54	1,63	

Displacements under service loads THE anchor		Performances							
		12		14		16		18	
$h_{nom}$	Nominal embedment depth: [mm]	75	105	75	115	80	120	90	140
<b>Displacements under tension loads in uncracked concrete</b>									
N	Service tension load: [kN]	10,35	17,87	10,35	20,67	10,35	20,67	13,57	27,77
$\delta_{N0}$	Short term displacement: [mm]	0,10	0,11	0,12	0,15	0,12	0,20	0,17	0,23
$\delta_{N\infty}$	Long term displacement: [mm]	0,40	0,68	0,46	0,70	0,60	0,74	0,50	0,71
<b>Displacements under tension loads in cracked concrete</b>									
N	Service tension load: [kN]	7,24	12,51	7,24	14,47	7,24	14,47	9,50	19,44
$\delta_{N0}$	Short term displacement: [mm]	0,24	0,46	0,34	0,51	0,39	0,59	0,41	0,55
$\delta_{N\infty}$	Long term displacement: [mm]	1,32	1,78	1,40	1,80	1,41	1,85	1,56	2,08
<b>Displacements under shear loads in uncracked concrete</b>									
V	Service shear load: [kN]	17,73	17,73	25,10	25,10	22,14	33,12	36,10	38,47
$\delta_{V0}$	Short term displacement: [mm]	1,65	1,65	1,87	1,87	1,04	1,61	1,96	2,03
$\delta_{V\infty}$	Long term displacement: [mm]	2,48	2,48	2,81	2,81	1,56	2,42	2,94	3,05
<b>Displacements under shear loads in cracked concrete</b>									
V	Service shear load: [kN]	16,88	17,73	18,47	25,10	15,50	28,94	25,27	38,47
$\delta_{V0}$	Short term displacement: [mm]	1,30	1,34	1,40	1,70	0,86	1,56	1,34	1,80
$\delta_{V\infty}$	Long term displacement: [mm]	1,95	2,01	2,10	2,55	1,29	2,34	2,01	2,70

**THE screw anchor**

**Performances**

Displacements under static or quasi-static tension and shear loads

**Annex C8**





**Table C8: Displacements under service loads TXE anchor**

Displacements under service loads TXE anchor			Performances								
			6			8		10		12	
$h_{nom}$	Nominal embedment depth:	[mm]	35	40	55	50	65	55	85	75	105
<b>Displacements under tension loads in uncracked concrete</b>											
N	Service tension load:	[kN]	2,34	3,21	4,93	4,25	7,00	5,22	10,71	8,62	17,88
$\bar{\delta}_{N0}$	Short term displacement:	[mm]	0,04	0,04	0,06	0,09	0,10	0,10	0,12	0,12	0,18
$\bar{\delta}_{N\infty}$	Long term displacement:	[mm]	0,28	0,30	0,30	0,35	0,40	0,40	0,45	0,45	0,50
<b>Displacements under tension loads in cracked concrete</b>											
N	Service tension load:	[kN]	0,56	1,07	3,20	2,06	4,90	3,65	7,50	5,63	12,51
$\bar{\delta}_{N0}$	Short term displacement:	[mm]	0,06	0,07	0,14	0,13	0,15	0,17	0,18	0,20	0,23
$\bar{\delta}_{N\infty}$	Long term displacement:	[mm]	0,60	0,53	0,86	0,55	1,11	0,57	0,92	0,67	1,06
<b>Displacements under shear loads in uncracked concrete</b>											
V	Service shear load:	[kN]	4,36	5,06	5,06	7,70	8,37	9,50	13,75	18,90	19,91
$\bar{\delta}_{V0}$	Short term displacement:	[mm]	1,70	1,85	1,85	1,89	1,90	2,14	2,26	2,38	2,35
$\bar{\delta}_{V\infty}$	Long term displacement:	[mm]	2,60	2,78	2,78	2,84	2,85	3,21	3,39	3,57	3,53
<b>Displacements under shear loads in cracked concrete</b>											
V	Service shear load:	[kN]	3,40	3,80	4,00	5,40	6,80	6,70	13,75	13,20	19,91
$\bar{\delta}_{V0}$	Short term displacement:	[mm]	1,72	1,80	1,81	1,84	1,87	1,95	2,25	2,16	2,35
$\bar{\delta}_{V\infty}$	Long term displacement:	[mm]	2,58	2,70	2,72	2,76	2,81	2,93	3,38	3,24	3,53

TXE screw anchor

Performances

Displacements under static or quasi-static tension and shear loads

Annex C9



**Table C9: Essential characteristics for seismic performance category C1, THE anchor**

Essential characteristics for seismic performance category C1, THE anchor			Performances							
			6	8	10	12	14	18		
$h_{nom}$	Nominal embedment depth:	[mm]	40	55	50	65	85	105	115	140
<b>Steel failure for tension and shear loads</b>										
$N_{Rk,s,C1}$	Characteristic resistance:	[kN]	25,12	25,12	39,14	39,14	54,81	74,48	105,45	161,56
$\gamma_{Ms}$	Partial safety factor <sup>1)</sup> :	[-]	1,4							
$V_{Rk,s,C1}$	Characteristic resistance:	[kN]	5,9	9,4	8,7	11,7	19,2	23,5	31,7	44,1
$\gamma_{Ms}$	Partial safety factor <sup>1)</sup> :	[-]	1,5							
$\alpha_{gap}$	Factor for annular gap:	[-]	0,5							
<b>Pull out failure</b>										
$N_{Rk,p,C1}$	Characteristic resistance in cracked concrete:	[kN]	5,0	5,0	6,2	8,8	14,7	18,2	23,2	35,3
$\gamma_{inst}$	Robustness:	[-]	1,2	1,0	1,2	1,0	1,0	1,0	1,0	1,0
<b>Concrete cone failure</b>										
$h_{ef}$	Effective depth:	[mm]	30,0	43,0	37,5	50,5	67,0	83,5	92,0	112,0
$s_{cr,N}$	Spacing:	[mm]	3 x $h_{ef}$							
$c_{cr,N}$	Edge distance:	[mm]	1,5 x $h_{ef}$							
$\gamma_{inst}$	Installation safety factor:	[-]	1,2	1,0	1,2	1,0	1,0	1,0	1,0	1,0
<b>Concrete pry-out failure</b>										
$k_8$	Pry-out factor:	[-]	1,44	1,15	1,80	1,27	2,00	2,00	2,00	2,00
$\gamma_{inst}$	Installation safety factor:	[-]	1,0							
<b>Concrete edge failure</b>										
$l_f$	Effective length of fastener under shear loads:	[mm]	30,0	43,0	37,5	50,5	67,0	83,5	92,0	112,0
$d_{nom}$	Outside fastener diameter:	[mm]	6	6	8	8	10	12	14	18
$\gamma_{inst}$	Installation safety factor:	[-]	1,0							

<sup>1)</sup> In absence of other national regulations

**THE screw anchor**

**Performances**

Essential characteristics for seismic performance category C1

**Annex C10**



**Table C10: Essential characteristics for seismic performance category C1, TXE anchor**

Essential characteristics for seismic performance category C1, TXE anchor			Performances							
			6		8		10		12	
$h_{nom}$	Nominal embedment depth:	[mm]	40	55	50	65	55	85	75	105
<b>Shear loads: steel failure without lever arm</b>										
$N_{Rk,s,C1}$	Characteristic resistance:	[kN]	17,58		29,30		48,13		69,67	
$\gamma_{Ms}$	Partial safety factor <sup>1)</sup> :	[-]	1,5							
$V_{Rk,s,C1}$	Characteristic resistance:	[kN]	5,83	8,44	8,04	10,00	15,16	19,86	25,96	30,80
$\gamma_{Ms}$	Partial safety factor <sup>1)</sup> :	[-]	1,25							
$\alpha_{gap}$	Factor for annular gap:	[-]	0,5							
<b>Pull out failure</b>										
$N_{Rk,p,C1}$	Characteristic resistance in cracked concrete:	[kN]	2,12	5,70	3,64	8,77	6,69	12,84	9,87	21,53
$\gamma_{inst}$	Robustness:	[-]	1,2	1,2	1,2	1,2	1,2	1,2	1,2	1,0
<b>Concrete cone failure</b>										
$h_{ef}$	Effective depth:	[mm]	30,0	43,0	37,5	50,5	41,5	67,0	58,0	83,5
$s_{cr,N}$	Spacing:	[mm]	3 x $h_{ef}$							
$c_{cr,N}$	Edge distance:	[mm]	1,5 x $h_{ef}$							
$\gamma_{inst}$	Installation safety factor:	[-]	1,2	1,2	1,2	1,2	1,2	1,2	1,2	1,0
<b>Concrete pry-out failure</b>										
$k_8$	Pry-out factor:	[-]	1,66	1,05	1,71	1,39	1,83	2,00	2,19	2,00
$\gamma_{inst}$	Installation safety factor:	[-]	1,0							
<b>Concrete edge failure</b>										
$l_f$	Effective length of fastener under shear loads:	[mm]	30,0	43,0	37,5	50,5	41,5	67,0	58,0	83,5
$d_{nom}$	Outside fastener diameter:	[mm]	6		8		10		12	
$\gamma_{inst}$	Installation safety factor:	[-]	1,0							

<sup>1)</sup> In absence of other national regulations

**TXE screw anchor**

**Performances**

Essential characteristics for seismic performance category C1

**Annex C11**



**Table C11: Essential characteristics for seismic performance category C2, THE anchor**

Essential characteristics for seismic performance category C2, THE anchor			Performances						
			6	8		10	12	14	18
$h_{nom}$	Nominal embedment depth:	[mm]	--	50	65	85	105	115	140
<b>Steel failure for tension and shear loads</b>									
$N_{Rk,s,C2}$	Characteristic resistance:	[kN]	--	39,14	39,14	54,81	74,48	105,45	161,56
$\gamma_{Ms}$	Partial safety factor <sup>1)</sup> :	[-]	1,4						
$V_{Rk,s,C2}$	Characteristic resistance:	[kN]	--	8,4	11,7	19,2	23,5	31,7	44,1
$\gamma_{Ms}$	Partial safety factor <sup>1)</sup> :	[-]	1,5						
$\alpha_{gap}$	Factor for annular gap:	[-]	0,5						
<b>Pull out failure</b>									
$N_{Rk,p,C2}$	Characteristic resistance in cracked concrete:	[kN]	--	2,3	3,4	6,9	10,5	15,3	31,5
$\gamma_{inst}$	Robustness:	[-]	--	1,2	1,0	1,0	1,0	1,0	1,0
<b>Concrete cone failure</b>									
$h_{ef}$	Effective depth:	[mm]	--	37,5	50,5	67,0	83,5	92,0	112,0
$s_{cr,N}$	Spacing:	[mm]	--	3 x $h_{ef}$					
$c_{cr,N}$	Edge distance:	[mm]	--	1,5 x $h_{ef}$					
$\gamma_{inst}$	Installation safety factor:	[-]	--	1,0					
<b>Concrete pry-out failure</b>									
$k_8$	Pry-out factor:	[-]	--	1,80	1,27	2,00	2,00	2,00	2,00
$\gamma_{inst}$	Installation safety factor:	[-]	--	1,0					
<b>Concrete edge failure</b>									
$l_f$	Effective length of fastener under shear loads:	[mm]	--	37,5	50,5	67,0	83,5	92,0	112,0
$d_{nom}$	Outside fastener diameter:	[mm]	--	8	8	10	12	14	18
$\gamma_{inst}$	Installation safety factor:	[-]	--	1,0					
<b>Displacements</b>									
$\delta_{N,C2}$ (DLS)	Displacement Damage Limitation State: <sup>2)</sup>	[mm]	--	0,36	0,16	0,22	0,41	0,25	0,66
$\delta_{V,C2}$ (DLS)	Displacement Damage Limitation State: <sup>2)</sup>	[mm]	--	1,60	0,79	1,13	1,69	1,52	1,69
$\delta_{N,C2}$ (ULS)	Displacement Ultimate Limit State: <sup>2)</sup>	[mm]	--	1,08	2,70	3,11	2,61	2,32	1,89
$\delta_{V,C2}$ (ULS)	Displacement Ultimate Limit State: <sup>2)</sup>	[mm]	--	2,54	4,74	7,43	9,03	6,29	8,79
DLS	Damage Limitation State: see EN 1992-4, 2.2.1)								
ULS	Ultimate Limitation State: see EN 1992-4 2.2.1)								

<sup>1)</sup> In absence of other national regulations

<sup>2)</sup> The listed displacements represent mean values

**THE screw anchor**

**Performances**

Essential characteristics for seismic performance category C2

**Annex C12**



**Table C12: Essential characteristics under fire exposure, THE anchor**

Essential characteristics under fire exposure, THE anchor				Performances						
				6			8		10	
$h_{nom}$	Nominal embedment depth:	[mm]	35	40	55	50	65	55	75	85
<b>Steel failure</b>										
$N_{Rk,s,fi}$	Characteristic tension resistance:	R30 [kN]	0,26			0,45		1,07		
		R60 [kN]	0,23			0,41		0,93		
		R90 [kN]	0,18			0,32		0,71		
		R120 [kN]	0,13			0,23		0,57		
$V_{Rk,s,fi}$	Characteristic shear resistance:	R30 [kN]	0,26			0,45		1,07		
		R60 [kN]	0,23			0,41		0,93		
		R90 [kN]	0,18			0,32		0,71		
		R120 [kN]	0,13			0,23		0,57		
$M^0_{Rk,s,fi}$	Characteristic bending resistance:	R30 [Nm]	0,22			0,52		1,52		
		R60 [Nm]	0,20			0,46		1,32		
		R90 [Nm]	0,16			0,36		1,02		
		R120 [Nm]	0,11			0,26		0,81		
<b>Pull out failure</b>										
$N_{Rk,c,fi}$	Characteristic resistance:	R30 - R90 [kN]	1,14	1,41	2,43	1,98	3,09	2,30	3,85	4,72
		R120 [kN]	0,91	1,13	1,94	1,58	2,47	1,84	3,08	3,78
<b>Concrete cone failure <sup>1)</sup></b>										
$N_{Rk,c,fi}$	Characteristic resistance:	R30 - R90 [kN]	0,59	0,85	2,09	1,48	3,12	1,91	4,51	6,33
		R120 [kN]	0,47	0,68	1,67	1,19	2,50	1,53	3,61	5,06
$S_{cr,N,fi}$	Critical spacing:	R30 - R120 [mm]	4 x $h_{ef}$							
$S_{min,fi}$	Minimum spacing:	R30 - R120 [mm]	35		35		50			
$C_{cr,N,fi}$	Critical edge distance:	R30 - R120 [mm]	2 x $h_{ef}$							
$C_{min,fi}$	Minimum edge distance:	R30 - R120 [mm]	$C_{min} = 2 \times h_{ef}$ ; if fire attack comes from more than one side, the edge distance of the anchor has to be $\geq 300$ mm							
<b>Concrete pry out failure</b>										
$k_8$	Pry-out factor:	R307 [mm]	2,05	1,44	1,15	1,80	1,27	1,95	1,32	2,00

<sup>1)</sup> As a rule, splitting failure can be neglected since cracked concrete and reinforcement is assumed.

In absence of other national regulations the partial safety factor for resistance under fire exposure  $\gamma_{m,fi} = 1,0$  is recommended

**THE screw anchor**

**Performances**

Essential characteristics under fire exposure

**Annex C13**



**Table C13: Essential characteristics under fire exposure, THE anchor (cont)**

Essential characteristics under fire exposure, THE anchor			Performances							
			12		14		16		18	
$h_{nom}$	Nominal embedment depth:	[mm]	75	105	75	115	80	120	90	140
<b>Steel failure</b>										
$N_{Rk,s,fi}$	Characteristic tension resistance:	R30 [kN]	2,01		2,99		3,53		4,74	
		R60 [kN]	1,51		2,24		2,65		3,56	
		R90 [kN]	1,31		1,94		2,29		3,08	
		R120 [kN]	1,01		1,50		1,76		2,37	
$V_{Rk,s,fi}$	Characteristic shear resistance:	R30 [kN]	2,01		2,99		3,53		4,74	
		R60 [kN]	1,51		2,24		2,65		3,56	
		R90 [kN]	1,31		1,94		2,29		3,08	
		R120 [kN]	1,01		1,50		1,76		2,37	
$M^0_{Rk,s,fi}$	Characteristic bending resistance:	R30 [Nm]	3,42		6,19		7,94		12,37	
		R60 [Nm]	2,56		4,64		5,95		9,28	
		R90 [Nm]	2,22		4,02		5,16		8,04	
		R120 [Nm]	1,71		3,10		3,97		6,18	
<b>Pull out failure</b>										
$N_{Rk,p,fi}$	Characteristic resistance:	R30 - R90 [kN]	3,80	6,57	3,80	7,60	3,80	7,60	4,99	10,20
		R120 [kN]	3,04	5,25	3,04	6,08	3,04	6,08	3,99	8,16
<b>Concrete cone failure <sup>1)</sup></b>										
$N_{Rk,c,fi}$	Characteristic resistance:	R30 - R90 [kN]	4,41	10,97	4,41	13,98	4,41	13,98	6,93	22,86
		R120 [kN]	3,53	8,78	3,53	11,18	3,53	11,18	5,55	18,29
$S_{cr,N,fi}$	Critical spacing:	R30 - R120 [mm]	4 x $h_{ef}$							
$S_{min,fi}$	Minimum spacing:	R30 - R120 [mm]	75	80		80		90		
$C_{cr,N,fi}$	Critical edge distance:	R30 - R120 [mm]	2 x $h_{ef}$							
$C_{min,fi}$	Minimum edge distance:	R30 - R120 [mm]	$C_{min} = 2 \times h_{ef}$ ; if fire attack comes from more than one side, the edge distance of the anchor has to be $\geq 300$ mm							
<b>Concrete pry out failure</b>										
$k_8$	Pry-out factor:	R30 - R120 [mm]	2,33	2,00	2,55	2,00	2,14	2,00	2,66	2,00

<sup>1)</sup> As a rule, splitting failure can be neglected since cracked concrete and reinforcement is assumed.

In absence of other national regulations the partial safety factor for resistance under fire exposure  $\gamma_{m,fi} = 1,0$  is recommended

**THE screw anchor**

**Performances**

Essential characteristics under fire exposure

**Annex C14**



**Table C14: Essential characteristics under fire exposure, TXE anchor**

Essential characteristics under fire exposure, TXE anchor				Performances								
				6			8		10		12	
$h_{nom}$	Nominal embedment depth:	[mm]		35	40	55	50	65	55	85	75	105
<b>Steel failure</b>												
$N_{Rk,s,fi}$	Characteristic tension resistance:	R30	[kN]	0,24			0,79		1,64		2,95	
		R60	[kN]	0,22			0,63		1,31		2,45	
		R90	[kN]	0,17			0,48		1,05		1,96	
		R120	[kN]	0,12			0,40		0,92		1,57	
$V_{Rk,s,fi}$	Characteristic shear resistance:	R30	[kN]	0,24			0,79		1,64		2,95	
		R60	[kN]	0,22			0,63		1,31		2,45	
		R90	[kN]	0,17			0,48		1,05		1,96	
		R120	[kN]	0,12			0,40		0,92		1,57	
$M^0_{Rk,s,fi}$	Characteristic bending resistance:	R30	[Nm]	0,20			0,84		2,24		4,94	
		R60	[Nm]	0,18			0,67		1,79		4,12	
		R90	[Nm]	0,14			0,51		1,43		3,29	
		R120	[Nm]	0,10			0,42		1,26		2,63	
<b>Pull out failure</b>												
$N_{Rk,p,fi}$	Characteristic resistance:	R30-R90	[kN]	0,25	0,63	1,88	1,25	3,09	2,30	4,72	3,50	6,57
		R120	[kN]	0,20	0,50	1,50	1,00	2,47	1,84	3,78	2,80	5,25
<b>Concrete cone failure <sup>1)</sup></b>												
$N_{Rk,c,fi}$	Characteristic resistance:	R30-R90	[kN]	0,59	0,85	2,09	1,48	3,12	1,91	6,33	4,41	10,97
		R120	[kN]	0,47	0,68	1,67	1,19	2,50	1,53	5,06	3,53	8,78
$S_{cr,N,fi}$	Critical spacing:	R30 - R120	[mm]	4 x $h_{ef}$								
$S_{min,fi}$	Minimum spacing:	R30 - R120	[mm]	35		35		50		75		
$C_{cr,N,fi}$	Critical edge distance:	R30 - R120	[mm]	2 x $h_{ef}$								
$C_{min,fi}$	Minimum edge distance:	R30 - R120	[mm]	$C_{min} = 2 \times h_{ef}$ ; if fire attack comes from more than one side, the edge distance of the anchor has to be $\geq 300$ mm								
<b>Concrete pry out failure</b>												
$k_s$	Pry-out factor:	R30 - R120	[mm]	1,87	1,66	1,05	1,71	1,39	1,83	2,00	2,19	2,00
<sup>1)</sup> As a rule, splitting failure can be neglected since cracked concrete and reinforcement is assumed. In absence of other national regulations the partial safety factor for resistance under fire exposure $\gamma_{m,fi} = 1,0$ is recommended												
<b>TXE screw anchor</b>											<b>Annex C15</b>	
<b>Performances</b>												
Essential characteristics under fire exposure												

